

St. Paul's Epistle

An Inviting Community of Christ's Disciples

Volume 34, Issue 4

April, 2011

St. Paul's United
Methodist Church
105 E. Main St.
Elida, OH 45807
419-339-3801

espcoffice@embarqmail.com

Rev. Ruth Solo
419/909-9102

Cell Phone: 419/812-3032

espcpastor@embarqmail.com

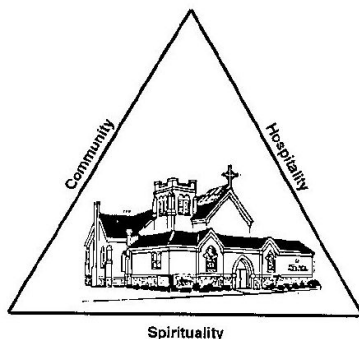

Dear Friends,

There is a story of a priest who was returning to his rectory one evening when he was accosted by a robber, who pulled a gun and said, "Your money or your life!" As the priest reached into his coat pocket, the robber saw his Roman collar and said, "I see you're a priest. Never mind. You can go." The priest tried to reciprocate by offering the robber a candy bar he remembered was in his pocket. The robber replied, "No thank you, Father. I don't eat candy during Lent."

We tend to think of those who practice the disciplines of Lent as being somehow more perfect than others. We think they are people who don't fall to temptation and sin. Yet, that is exactly what Lent is all about; to remind us that we all fall short. We all have something that we must get rid of in our lives if we are to be the people God intends for us to be.

No, we don't go out and rob our neighbors. But in the prayer of confession before communion, we admit that "we have broken [God's] law, we have rebelled against [God's] love, we have not loved our neighbors, and we have not heard the cry of the needy." We have failed God and our neighbors.

In the season of Lent, we have the opportunity to examine ourselves honestly before God and seek to live according to God's law of love toward all. I hope during this season, you are following one of several of the disciplines, involved in study of God's word, and being transformed into the likeness of Christ. And then, we can celebrate together the resurrection of Christ and the newness of all of our lives.

Have a blessed Holy Week and Easter Celebration! Peace to you all!

See you in church,
Pastor Ruth

Inside this issue:

| | |
|--------------------------|-----|
| Youth News | 2 |
| Upcoming Events | 2-3 |
| Northwest Plains News | 3 |
| The Heart of Church | 4 |
| ReFocus Effort | 5 |
| Faith In Action | 6 |
| Consulting the Manuel | 7 |
| Holy Week | 8 |
| Missions | 9 |
| Remember When... | 10 |
| Connecting With... | 11 |
| The People of St. Paul's | 12 |
| April Calendar | 13 |
| Recipes | 14 |
| Kidz Korner | 15 |
| Living Our Faith | 16 |



Thought for the Month:

Love is an act of
endless forgiveness,
a tender look which
becomes a habit.

~ Peter Ustinov

Youth News

Schedule of activities and events:

April 16 — 1 pm – Red's Game in Cincinnati followed by Jeremy Camp concert. About \$22 each. Provide own transportation. All are welcome. Must know by March 12 how many want to attend this to get discount tickets.

May — No youth activities because of Mother's Day, Prom, and preparations for graduation.

Watch for summer activities for youth with the Community Youth Ministry in coming months.

ACCOLADES FOR OUR YOUTH:

Michele Theodore: WLIO TV Scholar Athlete of the Week – Week of Feb. 28th; Winner of Scholastic Scholarship at Ohio Junior Miss competition

Reggie McAdams: Western Buckeye League Player of the Year in Basketball; 1st Team All-WBL Basketball; Named to 2nd Team All-Ohio in Division II Basketball.

Alex McAdams: 3rd Team All-WBL Basketball. WLIO TV Scholar Athlete of the Week— Week of March 14th.

Aric Thompson: Elida's top scorer with 18 points in Elida's Tournament win over Shawnee on March 1st.



Upcoming Events for St. Paul's

May 15th will be the last Sunday for the Children and Youth Ministry. They will not meet during the summer.

April 16, 2010
St. Paul's Chicken Barbeque
5-7:00 PM
Tickets are \$7.00
Menu: half chicken, homemade potato salad, applesauce, roll, and homemade desserts



| St. Paul's Epistle | |
|--|---------------|
| is published by St. Paul's United Methodist Church | |
| Subscription Rate: NONE | |
| Editor: | Judy Chaffins |
| Secretary: | Gail Fessler |
| Secretary: | Jone Lane |
| Organist: | Linda Holman |
| Pianist: | Lois Cook |
| Youth Director: | Corinne Piper |
| Custodian: | Dave Decker |

The 4th Annual Bradley Joseph Memorial Golf Outing has been set for **Saturday, July 23, 2011, new location** – Colonial Golfers Club, S.R. 309, Harrod, OH. Please mark your calendars and look for more information as it becomes available, per John Fleming, Brad's Uncle and Event Coordinator.



Newsletter deadline: **the 16th** of each month

Compass Newsletters

Stay informed on the mission, ministry and events in the Northwest Plains District with our monthly newsletter and weekly updates. To submit items, email the District Office at nwplains@wocumc.org with complete event and contact information.

The staff of the District Office reserves the right to edit submissions as needed.



Links of Interest for Laity

PASTOR'S SCHEDULE:

This month, Pastor Ruth will be involved in a workshop on **Saturday, April 9**, in Columbus, so she will be out of town for the day. Other than that one continuing education day, the Pastor will be available. If you need to meet with her, or if any needs arise, please call her.

Devotional Life

The Upper Room <http://www.upperroom.org>
DevoZine, devotional for youth & youth workers
www.devoted2youth.org
Devotions from New Hampshire UMC newhampshirecommunitychurch.org/grow/devotions/
MethodX, young adult spirituality from UMC www.upperroom.org/MethodX
Links to assorted devotional sites www.crosswalk.com/devotionals

Spiritual Formation Links:

Sacred Space <http://sacredspace.ie/>
Methodist Spiritual Directors <http://www.fumsdri.org/>
Spiritual Directors International <http://www.sdiworld.org/>

Upcoming Events for St. Paul's

April 17, 2011
Palm Passion Sunday
10:30 AM Worship Service



April 21, 2011
Maundy Thursday Service
Experience a Seder to Communion Celebration
6:00 PM

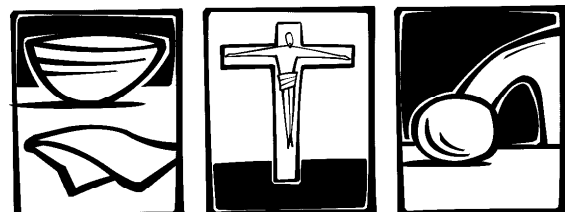

April 22, 2011
Community Good Friday Service
Allentown, Elida, Gomer Ministerial Association
Hosted by
Gomer United Church of Christ 7:00 PM
St. Paul's Choir will be singing

HOLY WEEK

April 24, 2011
EASTER SUNDAY
8:00 AM
Easter Sunrise Service
Featuring a drama "The Ragman" - by Walter Wangerin Jr.

Breakfast following the Sunrise Service provided by the Nurture Committee

10:30 AM
Easter Worship Service
Featuring our Chancel Choir
"Christ The Victor"





The Heart of Church

Greeters

| | |
|----------------|----------------------------|
| March 27, 2011 | Jerry & Becky Bean |
| April 3, 2011 | Marty & Kathy White |
| April 10, 2011 | Steve, Tracy & Tahler Sdao |
| April 17, 2011 | Denny & Carole Grapner |
| April 24, 2011 | Open |



OUR ANNUAL TOURNAMENT GAME/ PARKING EXTRAVAGANZA FUND RAISERS!

Once again this year, building on a tradition coordinated by **Don Chaffins** over the years and now spear-headed by **Art Holman**, members of our congregation took advantage of the high school basketball tournament games next door and parked cars on our grounds (and the Holman and Parsonage driveways) to generate money for our general fund. We parked four of six games and earned **\$513.00 (\$2/vehicle)**. On May 4, we worked as ticket takers, rope holders, and door attendants during the Boy's H.S. Div. IV Sectional Tournament final game and earned an additional **\$140.00** for a total of **\$653.00** this high school post-season basketball season. **Thanks to Larry Moser, Jamie Wyant, Tim Theodore, Tracy and Tahler Sdao, Rich Solo, and Marty White** for parking cars. **Thanks also to Dan and Margie Best; Scott, Gail, and Oliver Fessler; Lois Cook; Shirley Shoup; Dennis Bowsher; Kathy, Marty, and AJ White, Linda Holman, and Tim Piper** for working the May 4 tournament game. As basketball fund-raiser coordinator **Art Holman** likes to say, "It's the easiest **\$653** we ever made!" Thanks to all who helped earn this 'easy money.'

ST. PAUL'S SMALL GROUPS

| Group | Facilitator | Meeting Time |
|--|----------------|------------------------------------|
| Adult Bible Study | Art Holman | Sunday morning 9:15 to 10:05 AM |
| Pastor's Bible Study 3-4 short term studies per yr. | Pastor Ruth | Wednesday evenings 7:30 to 9:00 PM |
| Women's Bible study | Corinne Piper | Sunday mornings 9:15 to 10:00 AM |
| Cars | Jamie Wyant | Wednesday evenings at 6:30 PM |
| Healthy Living | Corinne Piper | Monday evenings 5:00 to 6:00 PM |
| Quilting/Crocheting "Crafty Creatures" | Carole Grapner | Wednesday evenings 6:30 PM |

ReFocus Effort



As we head into baseball season, one might say that the St. Paul's ReFocus Team is 'rounding second and heading for third'.

The Team's initial Summit Meeting 1 on January 29, 2011, looked back on the history of our congregation in discerning successes, failures, joys, frustrations, changes, challenges....but most importantly – lessons learned and the values we derived from our historical experiences. We drafted a value statement and the principles necessary for moving from 'maintenance' to 'mission' when serving as Christ's disciples throughout our community.

On February 26, 2011, Summit Meeting 2 was held. Participants reviewed and discussed results from a community survey our church members conducted last year. We learned what our neighbors seek in their daily lives from our schools, from our elected officials and governing bodies, and from local churches. They conveyed concerns with the integrity and vitality of our community and what voids need filled or opportunities need developed in growing prosperity among young and old alike. In preparation for this meeting, we also interviewed our leaders in local government and school district. From these surveys and discussions we determined 1)Who lives in our community and who attends St. Paul's; 2)The nature of our visitors and new members. This led us to examine who we minister to, how we change lives, and where we stand in the community. Video clips from movies 'Patch Adams' and 'Sister Act' helped inspire theories of mission and strategic values at St. Paul's. When common elements of these theories were examined, substantial impact areas appeared for use in a Vision Statement drafted by the Team. First draft of the Vision Statement:

**St. Paul's vision is for the Elida Community to be led to Christ
Through words and deeds enabling senior citizens to feel valued,
youth to have purpose, and families to be nurtured and supported.**

On March 26, 2011, Summit 3 will explore ministry structure, goals, and strategic initiatives for follow-up and implementation during an April Leadership Retreat. The end result is to transform our vision into reality by impacting lives and supporting our community. All are welcome to join us as we refocus St. Paul's for the future.

Jelly Bean Prayer

Red is for the blood he shed.
Green is for the grass he made.
Yellow is for the sun so bright.
Orange is for the edge of night.
Black is for the tomb – his grave.
White is for the grace he gave,
Purple is for the hour of sorrow,
Pink is for the new tomorrow.
Thank you, Jesus! Amen.



Committee Chairs

| | |
|-------------------------------------|-----------------------------|
| PPR Chair | Linda Craft |
| Trustees Chair | Tim Theodore |
| Finance Chair | Art Holman |
| Physical Plant Chair | Ron Steiner |
| Treasurer | Gene Craft |
| Assistant Treasurer | Jenessa Fletcher |
| Education Chair | TBA |
| Administrative Council Chair | Scott Fessler |
| Worship | Ruth Solo |
| Nurture | Martha Vazquez |
| Stewardship | Tim Piper |
| Missions | Marty White, Maedene Holmes |

Faith In Action

| Worship Attendance: | |
|----------------------------|----|
| February 27, 2011 | 94 |
| March 6, 2011 | 93 |
| March 13, 2011 | 88 |
| March 20, 2011 | 89 |

Financial Giving
Weekly Need for
Unified Ministry Budget
\$3,466.00

| Unified Ministry Giving: | | Other: |
|---------------------------------|------------|---------------|
| February 27, 2011 | \$3,414.00 | \$407.00 |
| March 6, 2011 | \$5,208.00 | \$714.77 |
| March 13, 2011 | \$2,320.00 | \$509.62 |
| March 20, 2011 | \$2,528.00 | \$703.00 |



**I am the resurrection
and the life**

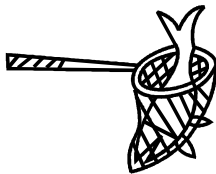

**Be ye fishers of men.
You catch them—He'll
clean them.**

| Children and Youth Ministry Attendance | |
|---|----|
| February 27, 2011 | 4 |
| March 6, 2011 | 12 |
| March 13, 2011 | 5 |
| March 20, 2011 | 12 |

| Flowers: | |
|-----------------|--------------------|
| March 27, 2011 | Fran Hall |
| April 3, 2011 | Gary & Janet Grigg |
| April 10, 2011 | Chris Bowsher |
| April 17, 2011 | Susan Nartker |
| April 24, 2011 | Gene & Linda Craft |

**Visit The United
Methodist Website at:
www.umw.org**

Consulting the Manual



Bible Readings for
 Revised Common Lectionary
 Year A

Week of April 3
Fourth Sunday in Lent

Color: Purple
Old Testament:
 1 Samuel 16:1-13
 Psalm 23
New Testament:
 Ephesians 5:8-14
 John 9:1-41
Preaching text:
 Matthew 27:11-26

Week of April 10
Fifth Sunday in Lent

Color: Purple
Old Testament:
 Ezekiel 37:1-14
 Psalm 130
New Testament:
 Romans 8:6-11
 John 11:1-45
Preaching text:
 Mark 15:15-20

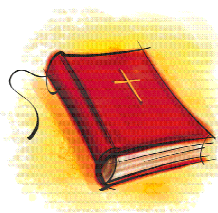

Week of April 17
Passion/Palm Sunday

Color: Purple
Palm Service:
 Matthew 21:1-11
 Psalm 118:1-2, 19-29
Passion Service:
 Isaiah 50:4-9a
 Psalm 31:9-16
 Philippians 2:5-11
 Matthew 26:14-27:66
Preaching text:
 Mark 15:15-39

Week of April 24
Easter

Color: White or Gold
Old Testament:
 Jeremiah 31:1-6
 Psalm 118:1-2, 14-24
New Testament:
 Acts 10:34-43
 Colossians 3:1-4
 John 20:1-18
Preaching text:
 John 20:1-18

For more detailed information on the
 Revised Common Lectionary,
 please visit:
www.gbod.org

Holy Week

Each year, the Christian church reviews the events leading up to Jesus' death and resurrection in a series of special days called Holy Week. The story of Jesus' suffering and death is difficult for people of all ages; still, it is at the heart of the Christian faith. Take time to experience the emotions of these Holy Week events together with others.

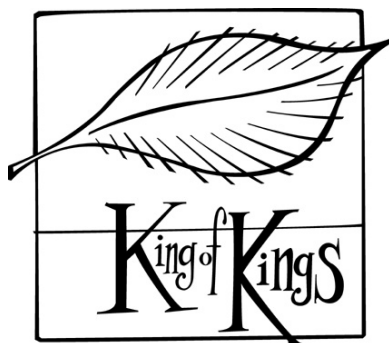

Palm Sunday
Matthew 21:1-11

In some congregations, this is called Palm/Passion Sunday because the service begins with a telling of Jesus' entry into Jerusalem and then later, the entire story of Jesus' death is read, which is sometimes called "the passion." The Jewish people in Jesus' time had been waiting over 500 years for a king. The Hebrew prophets had said God's promised messiah would govern Israel and also bring peace on earth and reconciliation with God. Many in the crowd expected Jesus to lead a revolt to overthrow the Romans and reestablish the kingdom of Israel, but the crowds would learn that Jesus was very different than the messiah they expected.



Maundy Thursday
John 13:1-17, 31b-35

On this night, during a celebration of the Passover, Jesus knelt to wash the feet of his disciples. After this meal Jesus also shared the last supper with his disciples - a meal we still remember and celebrate today in Holy Communion.



Good Friday
John 18:1--19:42

For Christians, Good Friday is one of the saddest days of the year. The same people who had shouted "Hosanna!" on Palm Sunday now cried "Crucify him!" This day of sorrow reminds us that even in impossible situations God can bring life and hope.



Easter Sunday
John 20:1-18

In the joy of Easter morning, the darkness of Jesus' death is turned to light and his wrongful death is turned to new life for all God's children. Easter celebrates new life, new joy, and new possibilities. This is a special Easter greeting you can share with friends and family!

One: Alleluia! Christ is risen.
All: Christ is risen indeed.

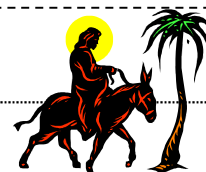

Palm Sunday... reminds us that at the moment of what seems to be the height of Jesus' public acceptance also begins the process of His public betrayal, His public failure, His public abandonment. Only in the mind of God is Jesus any longer a success, it seems... Here in the Passion narrative we trace the struggle, one scene at a time, between the Word of God and the ways of the world.

~ Joan Chittister

Missions Committee Report

The St. Paul's Missions Committee met February 15, 2011.

Actions from that meeting and other Missions activities:

- Marty, Kathy, and AJ White participated in Family Promise at Elida I.U.M. Friday, March 11. They provided an evening meal to a mother and her three children and joined with a couple from I.U.M. for evening entertainment activities;
- Our congregation hosted the February 5, 2011, breakfast meeting of the Lima Area Methodist Men (L.A.M.M.) Many of our members provided the menu items; Corinne Piper and Mary Grigsby helped with the breakfast set-up and service to meeting attendees. Tim Piper is our church liaison to this group;
- Allentown U.M.C. Pastor Neal Whitney reported to Tim Piper that the Five Loaves Food Pantry headquartered at Allentown U.M.C. is serving approx. 200 families each month, up from about 110 families one year ago. St. Paul's pantry donations, handled by Tim and the Sdaos, remain remarkable and steady;
- Jamie Wyant made a motion, seconded by Greg Schade during said Feb.15 meeting that our congregation, through its Missions Committee, donate \$220 or four \$55 scholarships to Camp Sierra Linda, Monterey, Mexico for its 2011 camp season. This camp and a related construction mission trip to re-build portions of it, are mission priorities of our Northwest Plains District this year. If you are interested in attending the July, 2011, Mexico construction mission trip, see Tim Piper or Marty White. Cost, including air and ground transportation, lodging, meals, and taxes is \$1,100;
- Slone Whetstone arranged for a presentation to our congregation during the March 6, 2011, service by a leader of the local Meals 'Til Monday non-profit organization. It was reported that over 75 sacked meals are prepared every Monday and distributed every Friday. Distributions initially were limited to Elida School District but now extend into Perry School District. Annual cost per child is \$120. Part of our 2010 Christmas offering went to this local mission;
- Jamie Wyant built a handicap ramp by himself during December, 2010. He stated it was a small ramp which didn't require additional assistance. As for the other two proposed ramp projects he advertized during a December Sunday service, Marimor funding hasn't arrived yet so these two projects are still on hold;
- Our annual summer mission trip to the Worthington United Methodist Children's home has been cancelled. Todd Hanes has declined leadership of on-site logistics and finances because of financial and personnel problems that have caused the home to drop its residential program. No one has agreed to step into Todd's former leadership position and for St. Paul's to attempt such leadership at this late date in February would be heroic to say the least. The Committee is looking into other mission work week options at present.



Marty White, Maedene Holmes, Co-Chairpersons

Remember When...



1990
Koinonia Chicken Barbeque



1994
Koinonia Chicken BBQ
The White Family



1998
Koinonia Chicken Barbeque
Carry Out Line

Connecting With ...

During February, 2010, I wrote and sent this to *The Lima News* for publication in their "Snow Angels" section. For some reason, it was not published. For 2011, it seems they (L.N.) published a few letters of this nature but did not formally solicit for another "Snow Angels" section. So our St. Paul's "Angels" are not forgotten, here is my letter from 2010 which still applies today. I'm sure there are others whose names can be added to the list but **Art, Ron, and Denny** are the main laborers in our congregation's snow removal efforts. **Thank you!**

THE SNOW ANGELS OF ST. PAUL'S, ELIDA

When it comes to church and the associated biblical teachings, we all know about guardian angels, good Samaritans, Christian hospitality and giving. St. Paul's U.M.C. in Elida has three individuals who have consistently and cheerfully displayed their overwhelming spirit of such Christian contribution not just during the recent snow storms, but during the past 15-20 winters. **Art Holman, Ron Steiner, and Denny Thompson** have courageously and tirelessly shoveled, blown, and plowed the snow-covered walks, entrances, ramps, and parking lot areas of St. Paul's church without hesitation and without compensation. This has been a true blessing to our congregation and to our community. Many thanks, gentlemen!

Marty White



Remember in Prayer



Recovering from Surgery or in the Hospital

Chris Bowsler
Joanna Hurd
Evelyn Sarber

Homebound Members

Hazel Dunn
Edna Osman
Jean Redd
Gladys Sherrick

Those in Need of Healing, Support, Strength & Encouragement

Rodney Lee

In the Military & Missions

Lesley Parker
Jason Stanley

Visit The United Methodist Communications website : www.umcom.org

This website offers book reviews, music reviews, and web ministry information among other relevant and interesting links.

Book of Timothy



The People of St. Paul's

*Thank you all,
For your prayers and
best wishes during my
recent surgery and
recuperation, they were
all very encouraging.*

*Bless you all,
Evelyn Sarber*

Thank You!

*Pastor Ruth and
Church family,
Thank you to our wonderful
friends and Pastor Ruth
for the many ways you held
us up during the untimely
death of my brother **Don
Ruese**. We very much
appreciated all the prayers,
cards, phone calls and
visits. Special thanks to the
Segovia's for braving the
elements and coming to the
funeral home. What kind
and generous people you
are! We felt so blessed to see
your faces in the crowd of
people. And **Pastor Ruth**, I
presented the eulogy
without tears. I miss my
brother so much.*

*God Bless you all,
Carl and Lois
Rabley*

*To St. Paul's UMC,
members and friends,
Thank you for the lovely
Serenity chimes, the
cards and the kind
expressions of sympathy
in the death of my
brother.*

*Rudy Segovia
and family*

*Barb & I would like to
thank the congregation,
for all of your love,
support, prayers, and
cards at the death of
my sister, **Mary Jo
Milke**. Also, thank
you **Pastor Ruth** for
helping us get through
this time of grief.*

Greg and Barb Schade



In Sympathy

We express our sympathy
to **Dan and Margie Best** on
the death of Dan's mother
Jean Best. She passed
away March 10, 2011. Her
funeral was held Monday,
March 14th in Columbus
Grove. Cards will reach
Dan and Margie at 4864
Hummingbird Street,
Elida, OH 45807



Prayer List Updates
Please Contact
Lavonne Segovia

Congratulations to **Mike
and Becky Ellinger**
on the birth of their
daughter **Sherilyn Irene
Ellinger** born February
18, 2011, at 6:31 PM. She
weighed 4lbs. 8oz. And
was 17 1/2 in. She went
home March 8th after 18
days in special care
nursery. The proud
grandparents are
Dennis and Kim Metzger.
Cards will reach Mike,
Becky and big sister
Adrianna at
11475 Heigle Rd SW
Stoutsville, OH 43154



Meetings

TBA
PPR...7:15 PM

April 5, 2011
Trustees...7:00 PM

April 6, 2011
Worship Team...
6:00 PM

April 11, 2011
Finance...7:00 PM

TBA
Stewardship

April 19, 2011
Missions...7:00 PM

Sundays
Prayer...10:00 AM
Fellowship...10:00 AM
Worship...10:30 AM

Thursdays
Chancel Choir...7:30

APRIL 2011

| May 2011 | | | | | | |
|----------|----|----|----|----|----|----|
| S | M | T | W | T | F | S |
| 1 | 2 | 3 | 4 | 5 | 6 | 7 |
| 8 | 9 | 10 | 11 | 12 | 13 | 14 |
| 15 | 16 | 17 | 18 | 19 | 20 | 21 |
| 22 | 23 | 24 | 25 | 26 | 27 | 28 |
| 29 | 30 | 31 | | | | |

| Sun | Mon | Tue | Wed | Thu | Fri | Sat |
|-----------------------|----------------------------------|----------------------|--|---------------------|----------------------|----------------------------|
| | | | | | 1 | 2 |
| 3 Helen Scholfield | 4 Ivan Vazquez Lynda Evans | 5 | 6 | 7 Dan Best | 8 | 9 |
| 10 Pam Lozano | 11 | 12 | 13 Worship Team | 14 | 15 Todd Chaffins | 16 Koinonia Chicken BBQ |
| 17 Doug Guess | 18 | 19 Maedene Holmes | 20 Lori Motzer Aaron Piper Kelly Warris | 21 | 22 Chloe Nartker | 23 |
| 24 Easter | 25 | 26 Kim Selover | 27 | 28 Jaxson Stemen | 29 Gerald Strayer | 30 |

Anniversaries

- Carl & Lois Rabley
April 4
47 yrs.
- Ray & Phyllis Trigg
April 15
51 yrs.
- John & Joy Fletcher
April 17
- Tony & Pam Lozano
April 17
- Brian & Angie Nartker
April 17
- Robert & Jacquie Bice
April 19
- Brad & Kim Selover
April 28

Featured Recipes from St. Paul's Great Cooks

Imitation Heath Bar Treats

by Lindsey Grapner-Clum

| Ingredients | | Instructions |
|-----------------|--|---|
| 1 box | Club Crackers | Preheat oven to 350 degrees. Line bottom of jelly roll pan with foil. Layer crackers tightly on top of foil. Melt sugar and butter in a sauce pan, cook 10 to 15 min. until mixture begins to thicken. Pour and spread evenly over all the crackers. Bake for 15 min. until bubbly and begins to look golden. Remove from oven and immediately sprinkle with baking chips. As they begin to melt, spread it over the top of all the crackers. Chill until the chocolate sets up. Peel off the foil and break into pieces. Store in air tight container. |
| 2 sticks (1cup) | Butter | |
| 1 cup | Sugar | |
| 1 pkg. | Baking Chips (Milk choc., semi sweet, dark or white or mixture of these) | |



Payday Bars

by Mary Irvin

| Ingredients | | Instructions |
|-------------|-------------------|---|
| 1 stick | Margarine | Preheat oven to 375 degrees. Cream together butter, sugars, and peanut butter. Add remaining ingredients, in the order given, except for marshmallow crème, nuts and chocolate chips. Spread in 9x13 inch pan. Spread jar of marshmallow crème over top. Sprinkle with chocolate chips and peanuts. Bake for 15 minutes. Cool completely before cutting. |
| 1/2 cup | Brown Sugar | |
| 1/2 cup | White Sugar | |
| 1/2 cup | Peanut Butter | |
| 1 | Egg | |
| 1/2 t. | Vanilla | |
| 1 1/2 cups | Flour | |
| 1/2 t. | Salt | |
| 2 t. | Baking Powder | |
| 7 oz. | Marshmallow Creme | |
| 6oz. | Chocolate Chips | |
| 1cup | Peanuts | |

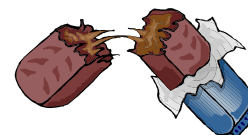

KIDZ KORNER

What Did Mary Say to the Disciples?

To find the answer, start at one of the openings. Make your way through the maze, writing the letters in the blanks as you pass them. If you run into a blocked path (line) you must start over at another opening (see John 20:18).

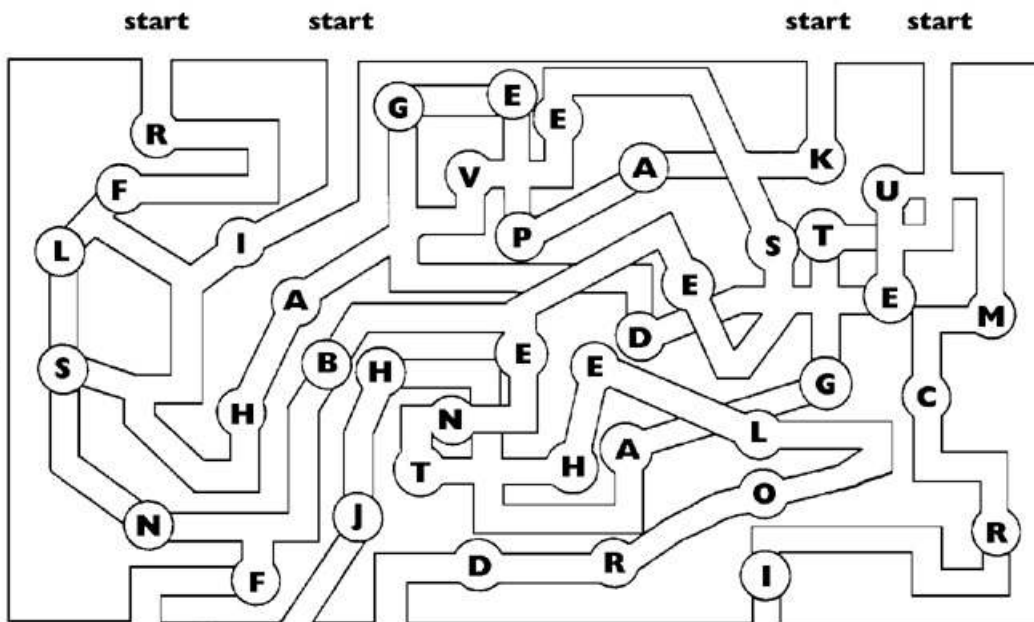

I have seen the Lord.
Answer

Word Find

Find words from John 10:1-10 in the word search.

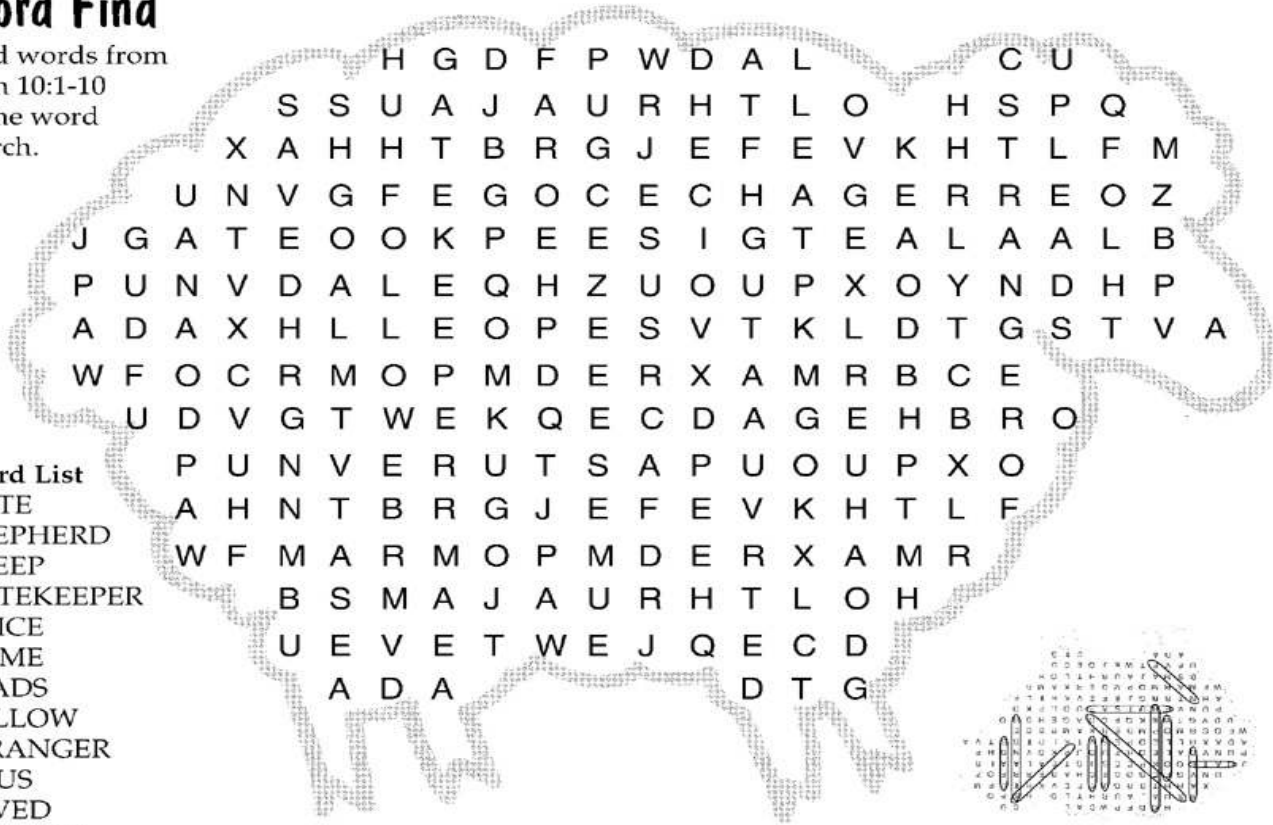

- Word List**
 GATE
 SHEPHERD
 SHEEP
 GATEKEEPER
 VOICE
 NAME
 LEADS
 FOLLOW
 STRANGER
 JESUS
 SAVED
 PASTURE

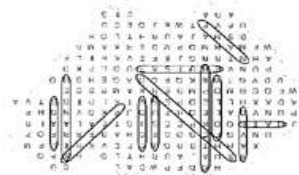

St. Paul's United Methodist Church

105 E. Main St.
Elida, OH 45807

*Return Service Requested

Non-Profit
Organization
U.S. Postage
PAID
Elida, OH
45807
Permit No. 71

Our Web Address:
www.elidastpaulschurch.org



Living Our Faith

When Is Easter?

Every year the date of Easter changes. The main reason is that unlike holidays which are tied to specific dates, Easter always falls on a Sunday. Also, because the events of Jesus' death and resurrection occurred in the context of the Jewish Passover festival (remember, Jesus and the disciples were Jewish), the date follows the Jewish pattern of being tied to the lunar calendar.

Easter Sunday is always the first Sunday after the first full moon on or after March 21, the vernal equinox, or the first day of spring in the Northern Hemisphere.

Thus, Easter can fall anywhere in between March 22 and April 25.

To add to the confusion, Eastern churches (such as Russian and Greek Orthodox) use a slightly different calendar, and their Easter is about two weeks after the date celebrated by Western churches.

Several proposals have been raised throughout history to arrive at a fixed date, but none of them have taken off. The most recent occurred in 2001 when Eastern and Western dates coincided for the first time in centuries.

There is one major advantage to having the date change each year. As Christians we are called to follow Jesus and that often means being out of step with the rest of the world. When we follow a calendar that is just a little out of step, it reminds us of the call to challenge the direction the world may be going. The floating date of Easter can help us remember and celebrate this.

